



EDELHOLZPROFILE PROFILS EN BOIS PRÉCIEUX

ST+K
STAHEL+KÖNG AG

HOLZARTEN BOIS	03
RAHMEN CADRES	04
FICHTE WEISS LASIERT / ESCHÉ WEISS LASIERT ÉPICÉA TEINTÉ BLANC / FRÊNE TEINTÉ BLANC	06
FICHTE / GERUNDETE PROFILE ÉPICÉA / PROFILS ARRONDIS	07
FLACHPROFILE PROFILS HAUTS	08
KÄSTCHENPROFILE PROFILS HAUTS	09
DISTANZLEISTEN LISTES DE DISTANCE	11
KÄSTCHENPROFILE PROFILS HAUTS	12
DISTANZLEISTEN / AUFHÄNGELEISTEN «PLUS» LISTES DE DISTANCE / LISTES D'ACCROCHAGE «PLUS»	13
VIERKANTLEISTEN LISTES RÉCTANGLUAIRES	14
L-PROFILE CAISSES AMÉRICAINES	15
KEILRAHMEN CHÂSSIS	17
VERKAUFS- UND LIEFERBEDINGUNGEN CONDITIONS DE VENTE ET DE LIVRAISON	18



Ahorn Érable **AH**



Ahorn geölt Érable huilé



Birnbaum Poirier **BI**



Birnbaum geölt Poirier huilé



Mahagoni Acajou **MA**



Mahagoni geölt Acajou huilé

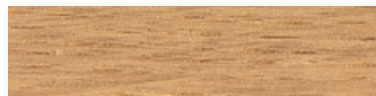

Eiche Chêne **EI**

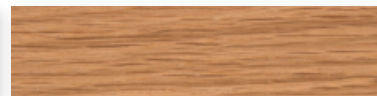

Eiche natur lackiert Frêne verni naturel



Esche Frêne **ES**



Esche weiss lasiert Frêne teinté blanc **ESW**



Fichte Épicéa **FI**



Fichte weiss lasiert Épicéa teinté blanc **FIW**



Kirschbaum Cerisier **KI**



Kirschbaum geölt Cerisier huilé



Linde Tilleul **LI**



Linde natur lackiert Tilleul verni naturel



Weymouth hell Weymouth non abouté **HE**



weiss deckend matt lackiert verni blanc couvrant mat



schwarz deckend matt lackiert verni noir couvrant mat

04/05

RAHMEN CARDES





Sichtbare Eckverbindung mit zwei Einsätzen 4 mm
Assemblage angulaire visible avec deux pièces de jonction par angle



Sichtbare Eckverbindung mit zwei Einsätzen 2,5 mm
Assemblage angulaire visible avec trois pièces de jonction par angle

Zusatz

Eckverbindung sichtbar verstärkt	Pro Rahmen
mit je 2 Einsätzen pro Rahmenecke	
mit je 3 Einsätzen pro Rahmenecke	
mit je 4 Einsätzen pro Rahmenecke	

Eckverbindungen unsichtbar verstärkt

Eckverbindung Lamello

Preis für Zuschnitte und Rahmen (nur Arbeit)

halber Umfang	bis 160 cm	bis 250 cm
Zuschnitt		
Leerrahmen (Naturholz)		
Rahmen, über Eck lackiert (weiss stumpfmatt, schwarz stumpfmatt, natur, weiss lasiert)		
Rahmen natur matt geölt		

halber Umfang über 250 cm: Preis auf Anfrage

+ Materialkosten

(Menge mindestens 2 Meter, auf den ganzen Meter aufgerundet)

Mengenrabatte

Stück		
2	10%	10%
5	20%	20%
10	30%	30%
20	40%	40%

Zuschläge Oberflächenbehandlung

Stäbe lackieren / lasieren
Stäbe ölen
Minimalbetrag

Plus-value

Assemblage angulaire visible	par cadre
avec 2 pièces de jonction par angle	
avec 3 pièces de jonction par angle	
avec 4 pièces de jonction par angle	

Assemblage renforcé non visible

Assemblage angulaire Lamello

Prix pour cadres coupés à l'onglet ou assemblés (uniquement travail)

demi-périmètre	jusqu'à 160 cm	jusqu'à 250 cm
cadre coupé à l'onglet		
cadre vide (bois brut)		
cadre, verni coins couverts (verni blanc mat, noir mat, naturel ou teinté blanc)		
cadre huilé mat		

demi-périmètre plus de 250 cm: prix sur demande

+ prix du profilé

(quantité arrondi au mètre suivant, min. 2 m)

Rabais de quantité

pièces		
2	10%	10%
5	20%	20%
10	30%	30%
20	40%	40%

Plus-value traitement de surface

vernir des baguettes
huiler des baguettes
montant minimum

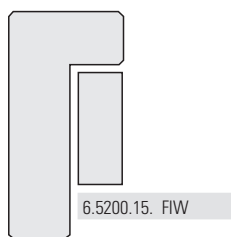

15.1828.30. FIW

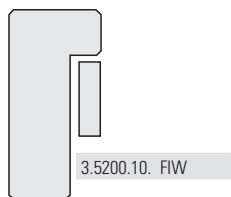

12.1829.25. FIW



20.1828.15. FIW



25.1828.15. FIW



30.1828.15. FIW

ESCHE WEISS LASIERT FRÊNE TEINTÉ BLANC

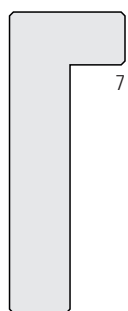

15.1820.40. ESW

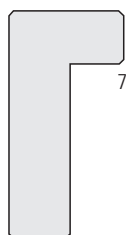

15.1820.30. ESW

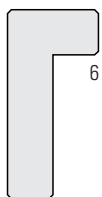

12.1820.25. ESW



5.5200.15. ESW



5.5200.10. ESW



6.5200.5. ESW

FICHTE WEISS LASIERT ÉPICÉA TEINTÉ BLANC



ESCHE WEISS LASIERT FRÊNE TEINTÉ BLANC





10.1829.25. FI

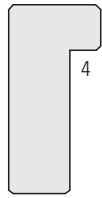

12.1829.25. FI

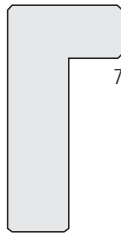

15.1828.30. FI



15.1828.50. FI

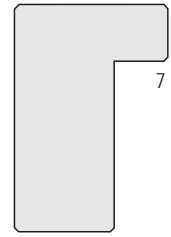

20.1828.30. FI

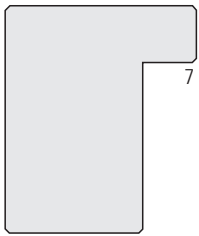

25.1828.30. FI



3.5200.10. FI



4.5200.10. FI



6.5200.5. FI



6.5200.15. FI



6.5200.35. FI

GERUNDETE PROFILE PROFILS ARRONDIS

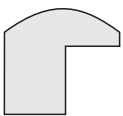

15.1605.14. HE

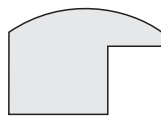

20.1605.14. HE



18.1616.15. LI

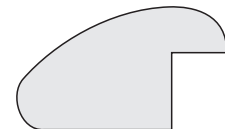

27.1616.16. LI

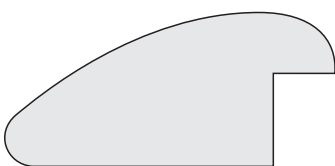

43.1616.20. LI

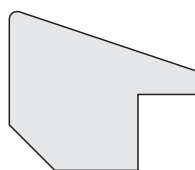

25.1235.21 LI
25.1235.21 KI

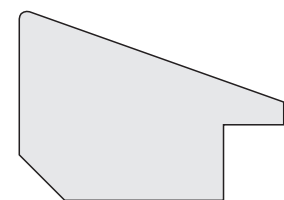

35.1235.25 LI
35.1235.25 KI



10.1200.11. AH
10.1200.11. BI
10.1200.11. HE
10.1200.11. KI



12.1200.11. AH
12.1200.11. EI
12.1200.11. HE
12.1200.11. KI



15.1200.12. AH
15.1200.12. BI
15.1200.12. EI
15.1200.12. HE
15.1200.12. KI

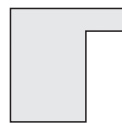

15.1200.15. AH
15.1200.15. EI
15.1200.15. HE
15.1200.15. LI
15.1200.15. KI

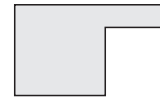

20.1200.12. AH
20.1200.12. EI
20.1200.12. HE
20.1200.12. LI



20.1200.15. AH
20.1200.15. EI
20.1200.15. HE
20.1200.15. LI

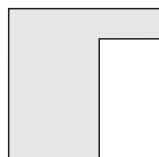

20.1200.20. AH
20.1200.20. EI
20.1200.20. HE
20.1200.20. KI
20.1200.20. LI



25.1200.15. AH
25.1200.15. EI
25.1200.15. HE
25.1200.15. LI

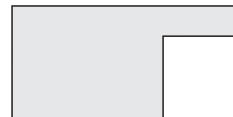

30.1200.15. AH
30.1200.15. EI
30.1200.15. HE
30.1200.15. LI

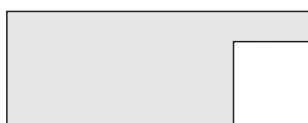

40.1200.15. AH
40.1200.15. EI
40.1200.15. HE
40.1200.15. LI



40.1200.20. AH
40.1200.20. EI
40.1200.20. LI



50.1200.20. EI
50.1200.20. LI

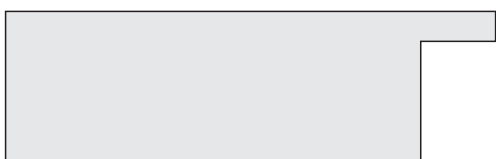

65.1200.20. EI
65.1200.20. LI



8.1200.11. HE
8.1200.11. LI

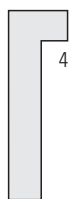

8.1815.25. AH
8.1815.25. EI
8.1815.25. ES
8.1815.25. HE
8.1815.25. KI
8.1815.25. LI
8.1815.25. MA



9.1200.15. AH
9.1200.15. EI
9.1200.15. KI
9.1200.15. LI



9.1200.20. AH
9.1200.20. EI
9.1200.20. KI
9.1200.20. LI

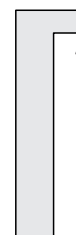

9.1200.30. AH
9.1200.30. EI
9.1200.30. KI
9.1200.30. LI

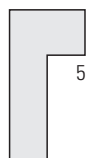

10.1820.20. AH
10.1820.20. EI
10.1820.20. HE
10.1820.20. LI

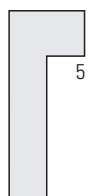

10.1820.25. AH
10.1820.25. EI
10.1820.25. ES
10.1820.25. HE
10.1820.25. KI
10.1820.25. LI
10.1820.25. MA

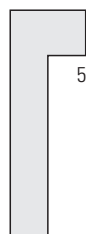

10.1820.30. AH
10.1820.30. EI
10.1820.30. ES
10.1820.30. HE
10.1820.30. KI
10.1820.30. LI
10.1820.30. MA

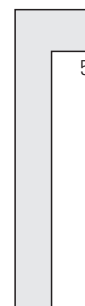

10.1820.40. AH
10.1820.40. EI
10.1820.40. HE
10.1820.40. KI
10.1820.40. LI
10.1820.40. MA

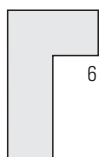

12.1820.20. AH
12.1820.20. EI
12.1820.20. HE
12.1820.20. LI

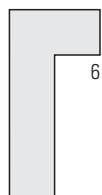

12.1820.25. AH
12.1820.25. BI
12.1820.25. EI
12.1820.25. ES
12.1820.25. HE
12.1820.25. KI
12.1820.25. LI
12.1820.25. MA

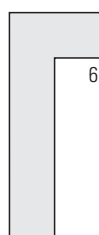

12.1820.30. AH
12.1820.30. EI
12.1820.30. HE
12.1820.30. LI



12.1820.40. AH
12.1820.40. EI
12.1820.40. ES
12.1820.40. HE
12.1820.40. KI
12.1820.40. LI
12.1820.40. MA

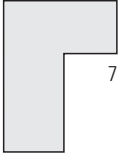

15.1825.20. AH
15.1825.20. EI
15.1825.20. HE
15.1825.20. LI

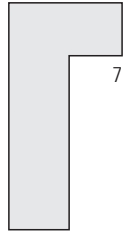

15.1825.30. AH
15.1825.30. BI
15.1825.30. EI
15.1825.30. ES
15.1825.30. HE
15.1825.30. KI
15.1825.30. LI
15.1825.30. MA

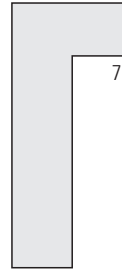

15.1825.35. AH
15.1825.35. EI
15.1825.35. HE
15.1825.35. LI



15.1825.40. AH
15.1825.40. EI
15.1825.40. HE
15.1825.40. LI
15.1825.40. ES

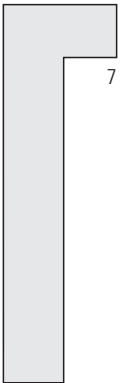

15.1825.50. AH
15.1825.50. EI
15.1825.50. HE
15.1825.50. LI
15.1825.50. ES

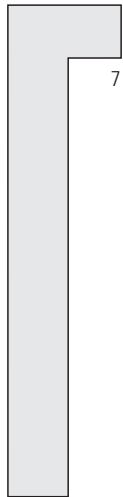

15.1825.65. HE
15.1825.65. LI

i DISTANZLEISTEN AUF SEITE 10
LISTES DE DISTANCE PAGE 10

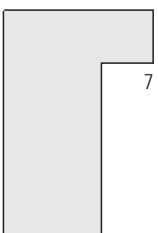

20.1825.30. AH
20.1825.30. EI
20.1825.30. ES
20.1825.30. HE
20.1825.30. LI
20.1825.30. MA

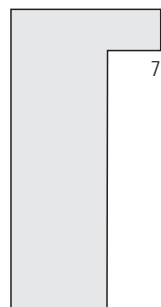

20.1825.40. HE
20.1825.40. LI

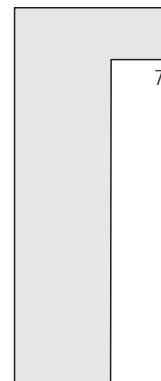

20.1825.50. LI
20.1825.50. AH
20.1825.50. MA

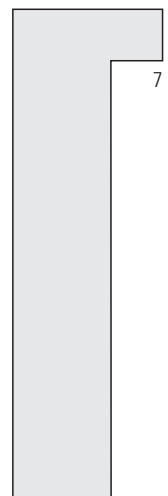

20.1825.65. LI
20.1825.65. ES



3.5200.4. AH
3.5200.4. EI
3.5200.4. ES
3.5200.4. HE
3.5200.4. KI
3.5200.4. LI
3.5200.4. MA



4.5200.6. AH
4.5200.6. EI
4.5200.6. ES
4.5200.6. HE
4.5200.6. KI
4.5200.6. LI
4.5200.6. MA



4.5200.10. AH
4.5200.10. EI
4.5200.10. ES
4.5200.10. FI
4.5200.10. HE
4.5200.10. KI
4.5200.10. LI
4.5200.10. MA



4.5200.15. AH
4.5200.15. EI
4.5200.15. HE
4.5200.15. KI
4.5200.15. LI
4.5200.15. MA



6.5200.5. AH
6.5200.5. EI
6.5200.5. ESW
6.5200.5. FI
6.5200.5. HE
6.5200.5. LI



5.5200.10. AH
5.5200.10. BI
5.5200.10. EI
5.5200.10. ES
5.5200.10. ESW
5.5200.10. HE
5.5200.10. KI
5.5200.10. LI
5.5200.10. MA



5.5200.15. AH
5.5200.15. EI
5.5200.15. ES
5.5200.15. ESW
5.5200.15. HE
5.5200.15. LI



5.5200.20. AH
5.5200.20. EI
5.5200.20. ES
5.5200.20. HE
5.5200.20. KI
5.5200.20. LI
5.5200.20. MA



6.5200.5. AH
6.5200.5. EI
6.5200.5. ESW
6.5200.5. FI
6.5200.5. HE
6.5200.5. LI



6.5200.8. HE



6.5200.10. AH
6.5200.10. BI
6.5200.10. EI
6.5200.10. ES
6.5200.10. HE
6.5200.10. KI
6.5200.10. LI
6.5200.10. MA



6.5200.15. AH
6.5200.15. EI
6.5200.15. ES
6.5200.15. FIW
6.5200.15. HE
6.5200.15. LI
6.5200.15. KI



6.5200.20. AH
6.5200.20. EI
6.5200.20. ES
6.5200.20. HE
6.5200.20. LI



6.5200.25. AH
6.5200.25. BI
6.5200.25. EI
6.5200.25. ES
6.5200.25. HE
6.5200.25. KI
6.5200.25. LI
6.5200.25. MA



6.5200.30. AH
6.5200.30. EI
6.5200.30. HE
6.5200.30. LI
6.5200.30. MA



6.5200.40. ES
6.5200.40. HE
6.5200.40. LI

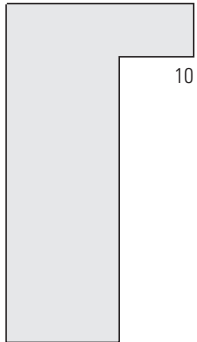

25.1205.45. EI
25.1205.45. ES
25.1205.45. HE
25.1205.45. LI

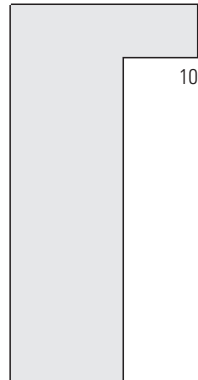

25.1205.50. AH
25.1205.50. EI
25.1205.50. ES
25.1205.50. LI
25.1205.50. MA

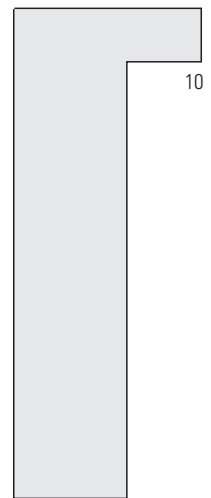

25.1205.65. LI

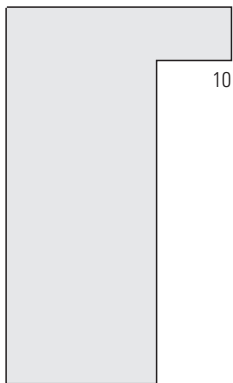

30.1205.50. LI

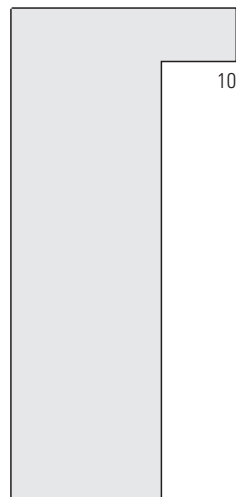

30.1205.65. ES
30.1205.65. FI
30.1205.65. LI

mit Überlänge bis
ca. 4000 mm } +25% Mehrpreis
sur demande jusqu'à } Plus-value de 25%
4000 mm env.



DISTANZLEISTEN AUF SEITE 13
LISTES DE DISTANCE PAGE 13



9.5200.10. HE
9.5200.10. LI



9.5200.15. AH
9.5200.15. HE
9.5200.15. LI



9.5200.20. AH
9.5200.20. EI
9.5200.20. HE
9.5200.20. LI



9.5200.25. AH
9.5200.25. EI
9.5200.25. ES
9.5200.25. HE
9.5200.25. LI
9.5200.25. MA



9.5200.30. LI



9.5200.40. ES
9.5200.40. FI
9.5200.40. LI

AUFHÄNGELEISTEN «PLUS» LISTES D'ACCROCHAGE «PLUS»



8.5210.20.



8.5210.40.

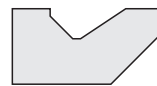

10.5210.20.



10.5210.40.



10.5210.50.



13.5210.50. AS



15.5210.30. BU



15.5210.50. AS

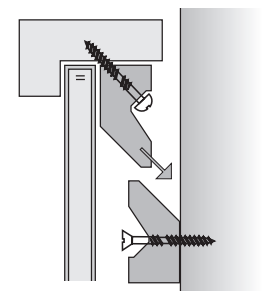
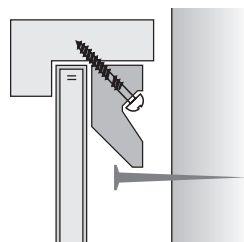



20.5200.20. FI



20.5200.30. FI

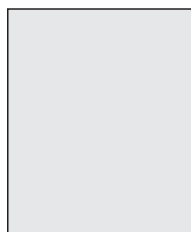

25.5200.30. FI



30.5200.30. FI

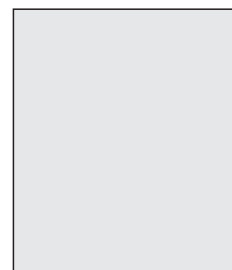

30.5200.35. FI

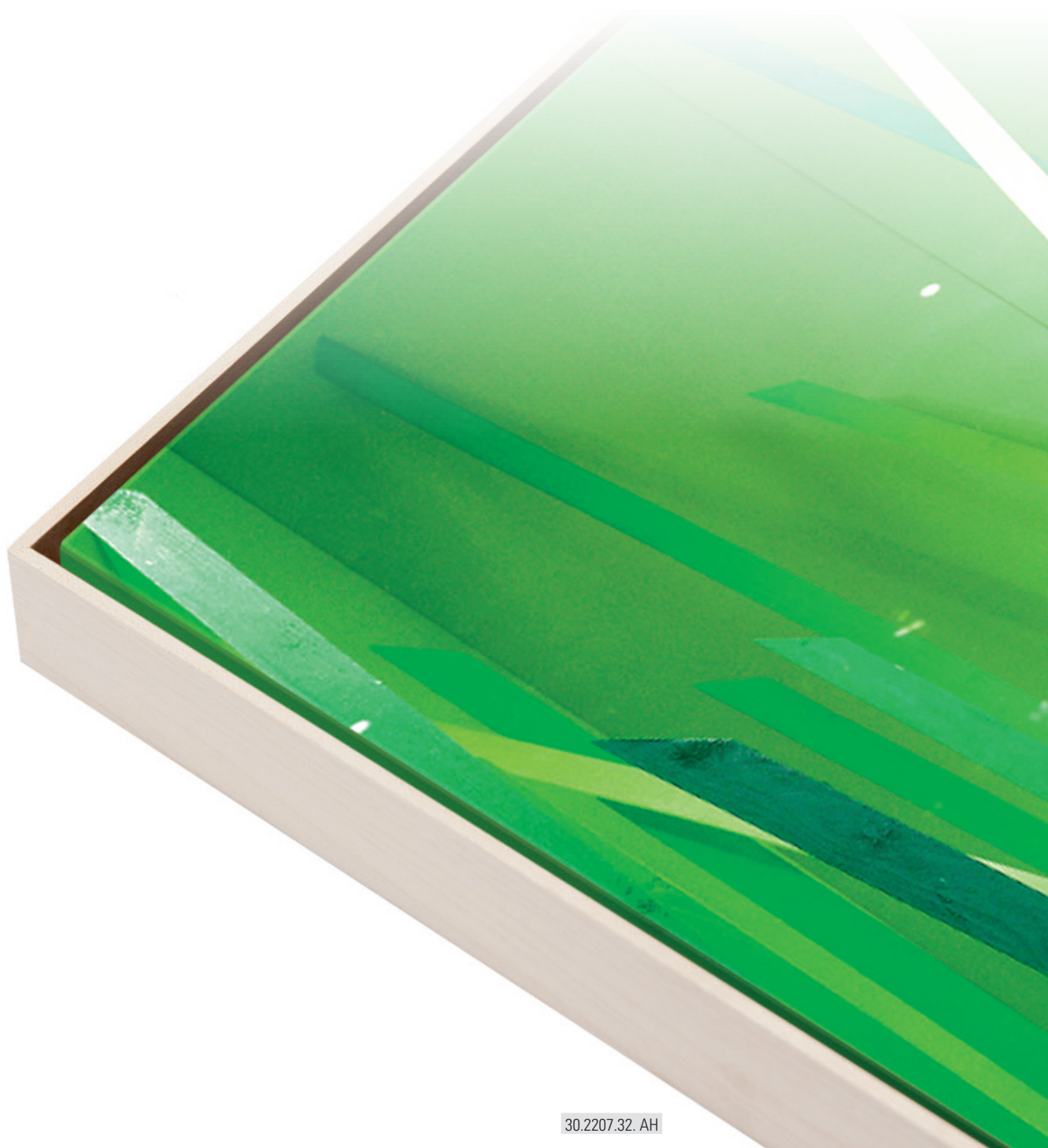

30.2207.32. AH

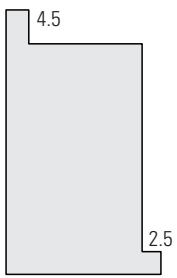

20.5250.35. LI

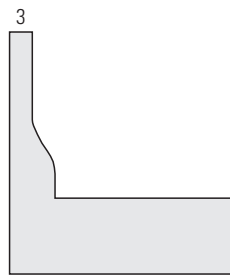

30.2207.32. AH
30.2207.32. EI
30.2207.32. KI
30.2207.32. LI

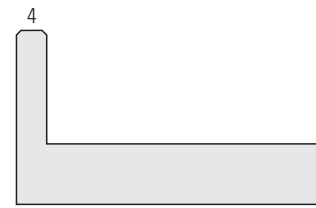

40.2215.27. FI
40.2215.27. LI

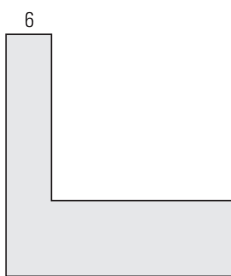

30.2202.32. AH
30.2202.32. EI
30.2202.32. ES
30.2202.32. FI
30.2202.32. HE
30.2202.32. LI
30.2202.32. MA

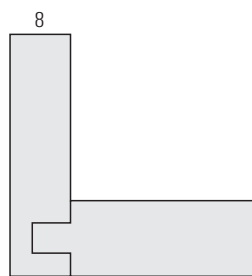

33.2203.32. AH
33.2203.32. EI
33.2203.32. FI
33.2203.32. HE
33.2203.32. LI
33.2203.32. MA

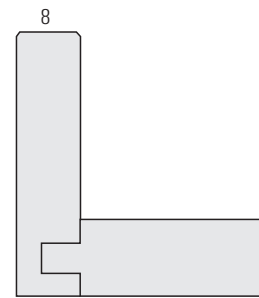

33.2215.35. AH
33.2215.35. EI
33.2215.35. FI
33.2215.35. HE
33.2215.35. LI

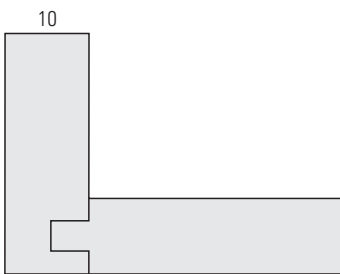

45.2201.32. AH
45.2201.32. EI
45.2201.32. FI
45.2201.32. HE
45.2201.32. LI

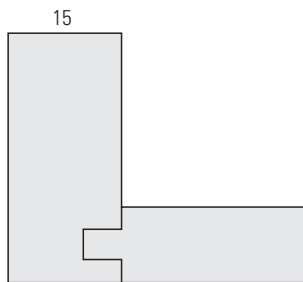

40.2205.33. AH
40.2205.33. EI
40.2205.33. ES
40.2205.33. HE
40.2205.33. LI
40.2205.33. MA

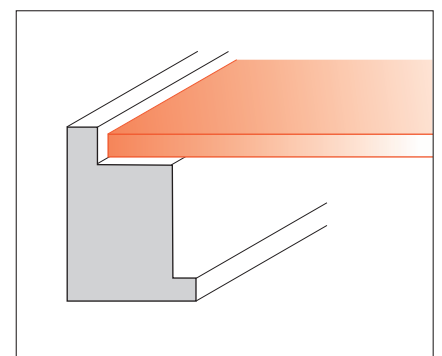
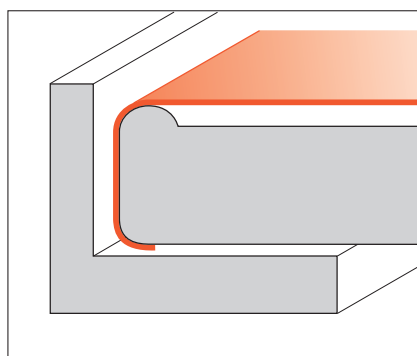
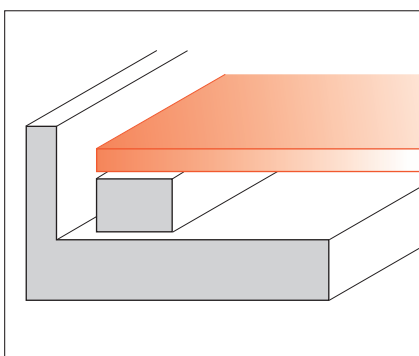

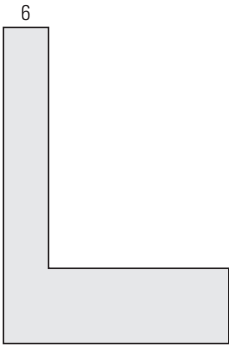

30.2202.42. FI
30.2202.42. HE
30.2202.42. LI

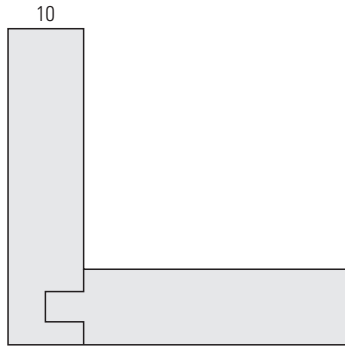

45.2201.42. FI
45.2201.42. HE

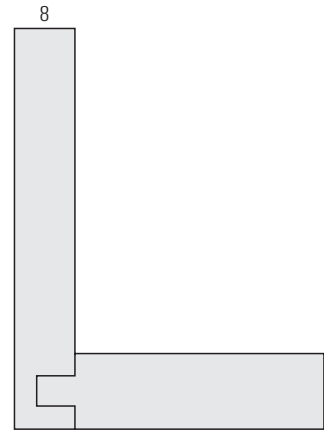

41.2203.53. FI
41.2203.53. HE
41.2203.53. LI



52.2201.65. FI
52.2201.65. LI

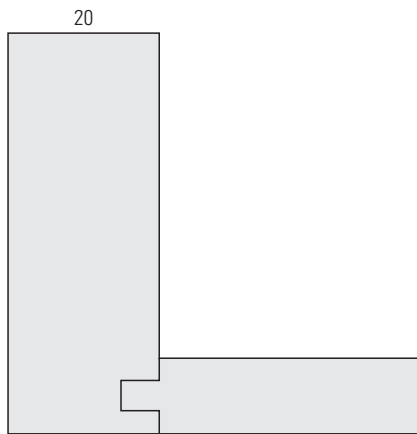

55.2210.53. FI
55.2210.53. HE
55.2210.53. LI

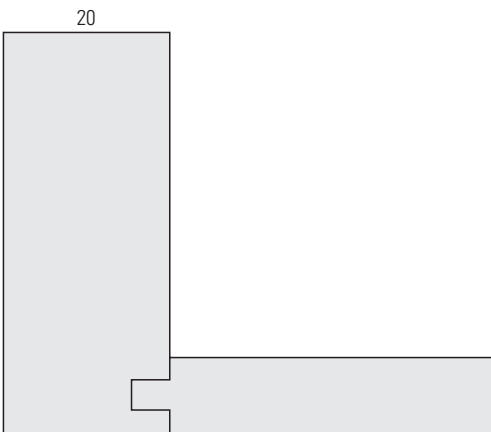

65.2230.53. LI
mit Überlänge bis ca.
4000 mm
sur demande jusqu'à
4000 mm env.

} +25% Mehrpreis
} Plus-value de 25%

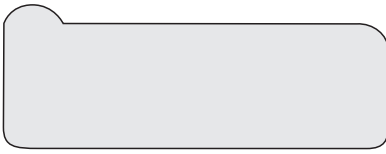

50.6000.19. K

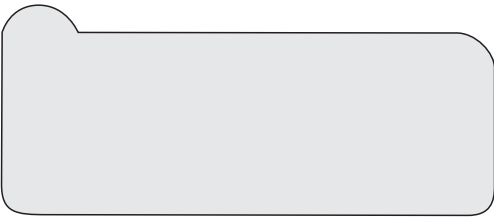

64.6000.28. K

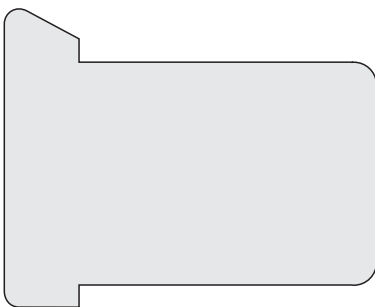

49.6000.39. K

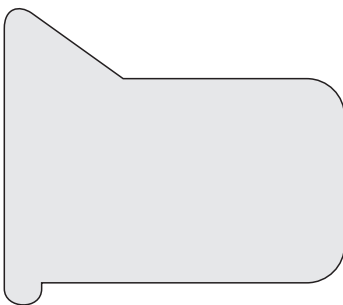

45.6000.39. K

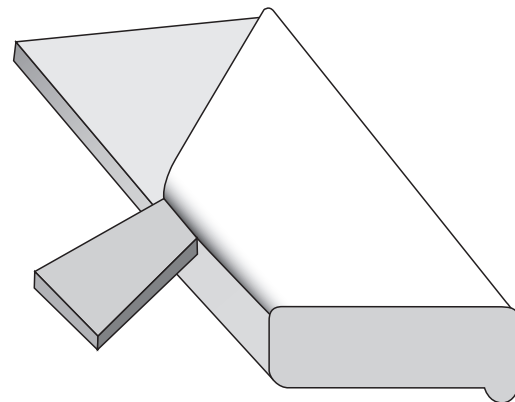
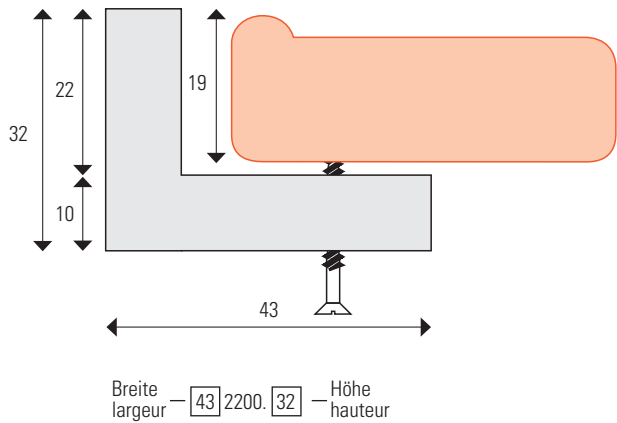

Preise pro Laufmeter, Keile inbegriffen
Kreuz 11.95 (Zuschlag für Arbeit)

Prix par ml, clés inclus
Croix 11.95 (plusvalue)

Top Qualität:
Espenholz – keilverzinkt und lamelliert
Aus vorbildlicher Waldwirtschaft

Top qualité:
Tremble –abouté et lamellé
Provenance de forêts bien gérées

50.6000.19.

Laufmeter (nicht zugeschnitten)
mètre linéaire (pas coupé à l'onglet)



Ausführungsvarianten

Die übliche Stablänge liegt zwischen 2 und 3 m, Überlängen bis 4 m.
Alle Stäbe sind ungezinkt und unverleimt.

Spezialanfertigungen

Auf Wunsch können wir alle gängigen Holz- und Profilarten liefern. Geringe Farb- und Strukturunterschiede des Holzes, wie z.B. Spiegel bei Eiche oder Riegel bei Ahorn, sind naturgegeben und zu akzeptieren. Bei Zuschnitten wählen wir möglichst homogene Schenkel.

Preise

Die Preise gelten je Laufmeter, ab Werk, exkl. MWST. Spezialanfertigungen in anderen Holzarten oder Profilformen auf Anfrage.

Mengenrabatte für Rahmen und Zuschnitte

2 Stück	10%
5 Stück	20%
10 Stück	30%
20 Stück	40%

Mengenrabatte für Lagerprofile

ab 12 lfm	3%
ab 24 lfm	6%
ab 60 lfm	12%
ab 150 lfm	16%

Preis für Zuschnitte und Rahmen (nur Arbeit)

halber Umfang	bis 160 cm	bis 250 cm
Zuschnitt		
Leerrahmen (Naturholz)		
Rahmen, über Eck lackiert (weiss stumpfmatt, schwarz stumpfmatt, natur, weiss lasiert)		
Rahmen natur matt geölt		
halber Umfang über 250 cm: Preis auf Anfrage		

+ Materialkosten

(Menge mindestens 2 Meter, auf den ganzen Meter aufgerundet)

Zuschläge Oberflächenbehandlung

Stäbe lackieren	4.00/m
Stäbe ölen	3.00/m
Minimalbetrag	45.00

Verpackungs- und Frachtkostenanteil kurze Pakete lange Pakete

	bis 170 cm	bis 310 cm
bis 10 kg		
bis 20 kg		
bis 30 kg		

Express-Aufträge und Pakete über 30 kg werden nach anfallenden Kosten verrechnet.

Beanstandungen

Bis spätestens 10 Tage nach Erhalt der Lieferung.

Mindestbezugsmenge

Lagerprofile 6 m je Sorte.

Mindestwarenwert**Zahlungskonditionen**

30 Tage, rein netto.

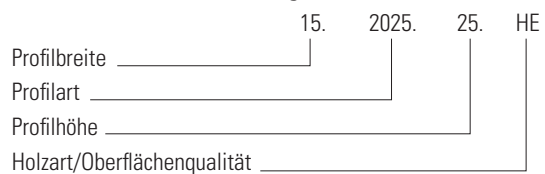
Aufbau der Profilbezeichnung

Types d'exécution

La longueur standard des baguettes est de 2 à 3 m, certains profils indiqués jusqu'à 4m. Toutes les baguettes ne sont pas dentelées (non abouté).

Fabrication sur mesure

Sur simple demande, nous pouvons vous fournir tous genres de bois habituels et chaque type de profil. Des différences de teinte naturelles devront être acceptées. Pour la coupe à l'onglet, nous sélectionnons les baguettes le plus possible selon des structures homogènes.

Prix

Les prix s'entendent mètre linéaire, à partir de l'usine. T.V.A. excluse. Toute fabrication spéciale dans un bois ou un profil différent sur demande.

Rabais de quantité pour cadres vides assemblés ou coupés à l'onglet

2 pièces	10%
5 pièces	20%
10 pièces	30%
20 pièces	40%

Rabais de quantité pour profils en stock

dès 12 m	3%
dès 24 m	6%
dès 60 m	12%
dès 150 m	16%

Prix pour cadres coupés à l'onglet ou assemblés (uniquement travail)

demi-périmètre	jusqu'à 160 cm	jusqu'à 250 cm
cadre coupé à l'onglet		
cadre vide (bois brut)		
cadre, verni coins couverts (verni blanc mat, noir mat, naturel ou teinté blanc)		
cadre huilé mat		
demi-périmètre plus de 250 cm: prix sur demande		

+ prix du profilé

(quantité arrondi au mètre suivant, min. 2 m)

Plus-value traitement de surface

vernir des baguettes	4.00 / m
huiler des baguettes	3.00 / m
montant minimum	45.00

Frais de livraison et d'emballage

	paquet court	paquet long
	à 170 cm	à 310 cm
jusqu'à 10 kg		
jusqu'à 20 kg		
jusqu'à 30 kg		

Réclamations

Les réclamations ne seront acceptées que 10 jours après réception de la livraison au plus tard.

Quantité minimum de livraison

Profils en stock, 6 m par type de profil.

Montant minimum de facturation

Conditions de paiement

Net à 30 jours.

Structure des numéros des profils

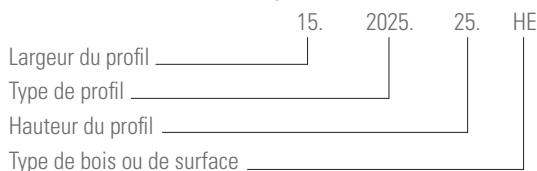



Stahel + Köng AG
Kemptnerstrasse 13
Postfach 396
CH-8340 Hinwil
Telefon +41 44 938 30 90
Telefax +41 44 937 48 39
E-Mail info@st-k.ch
www.st-k.ch

